

Konstruktion Dobson GSO 12 Zoll F4

Hut Oberseite, Birke Multiplex 8..10 mm

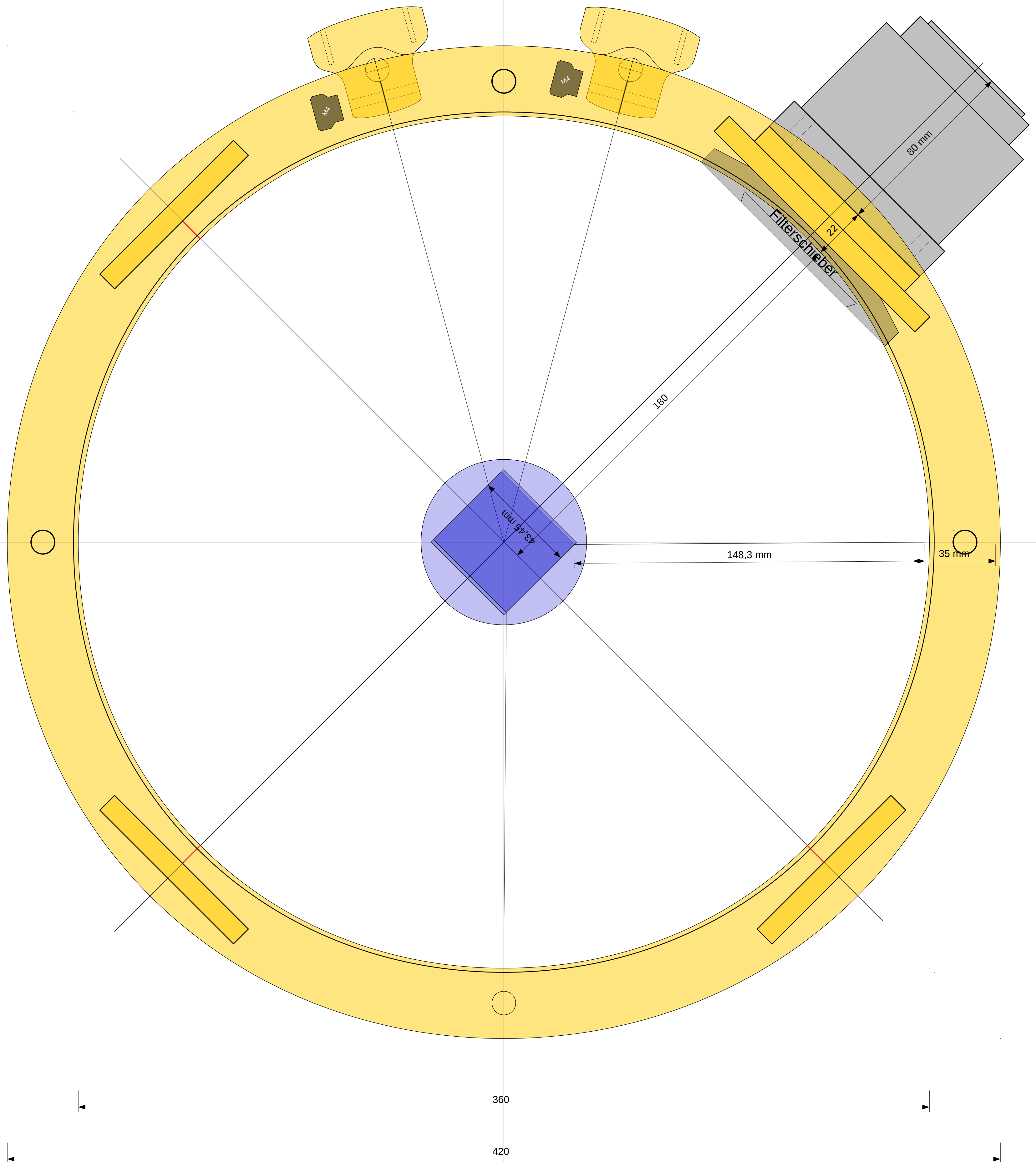

Konstruktion Dobson GSO 12 Zoll F4

Hut Unterseite, Birke Multiplex 8..10 mm

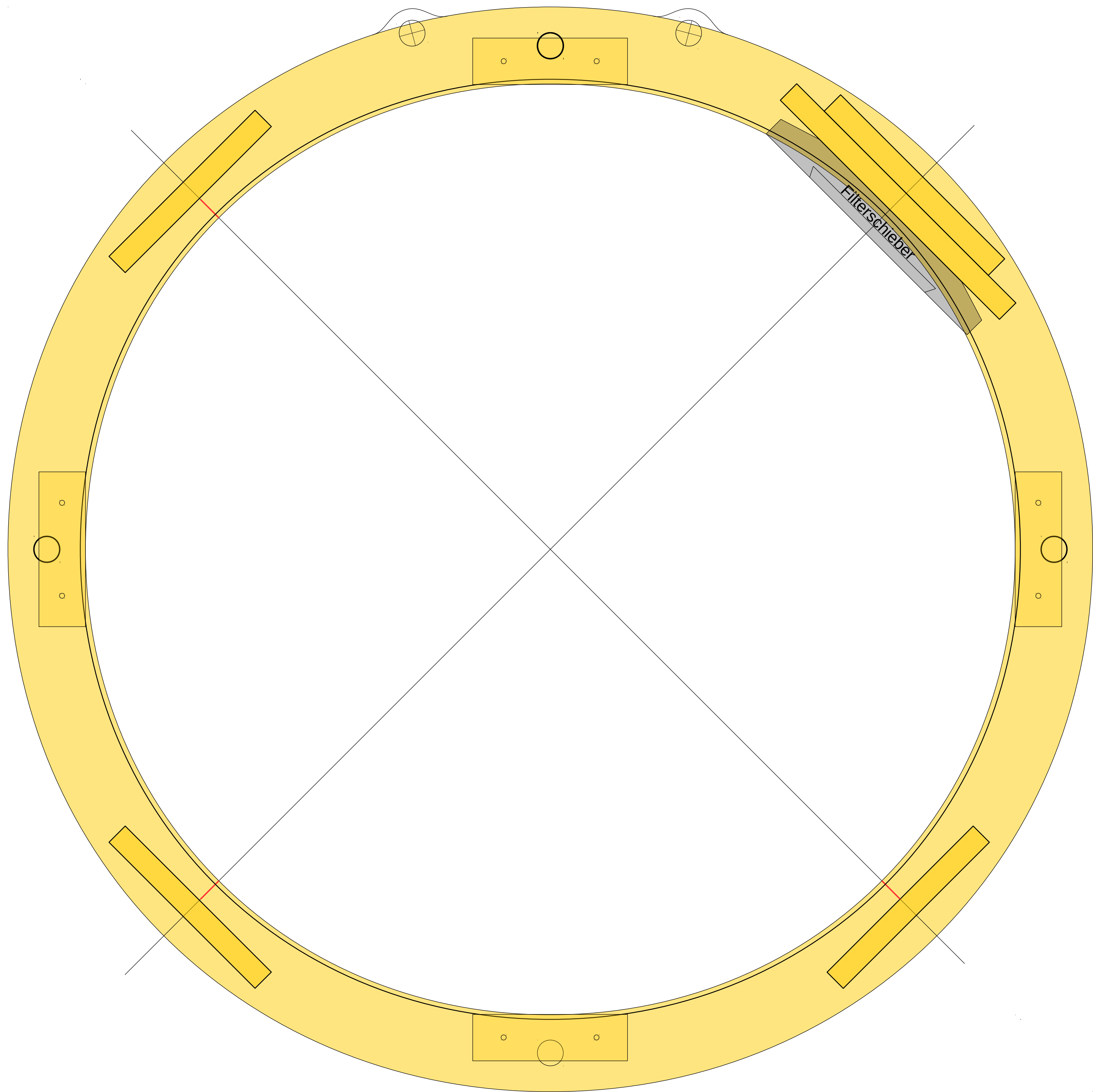

Konstruktion Dobson GSO 12 Zoll F4

Hut Stützbretter und Alustäbe für Spinnenbefestigung, Birke Multiplex 8..10 mm

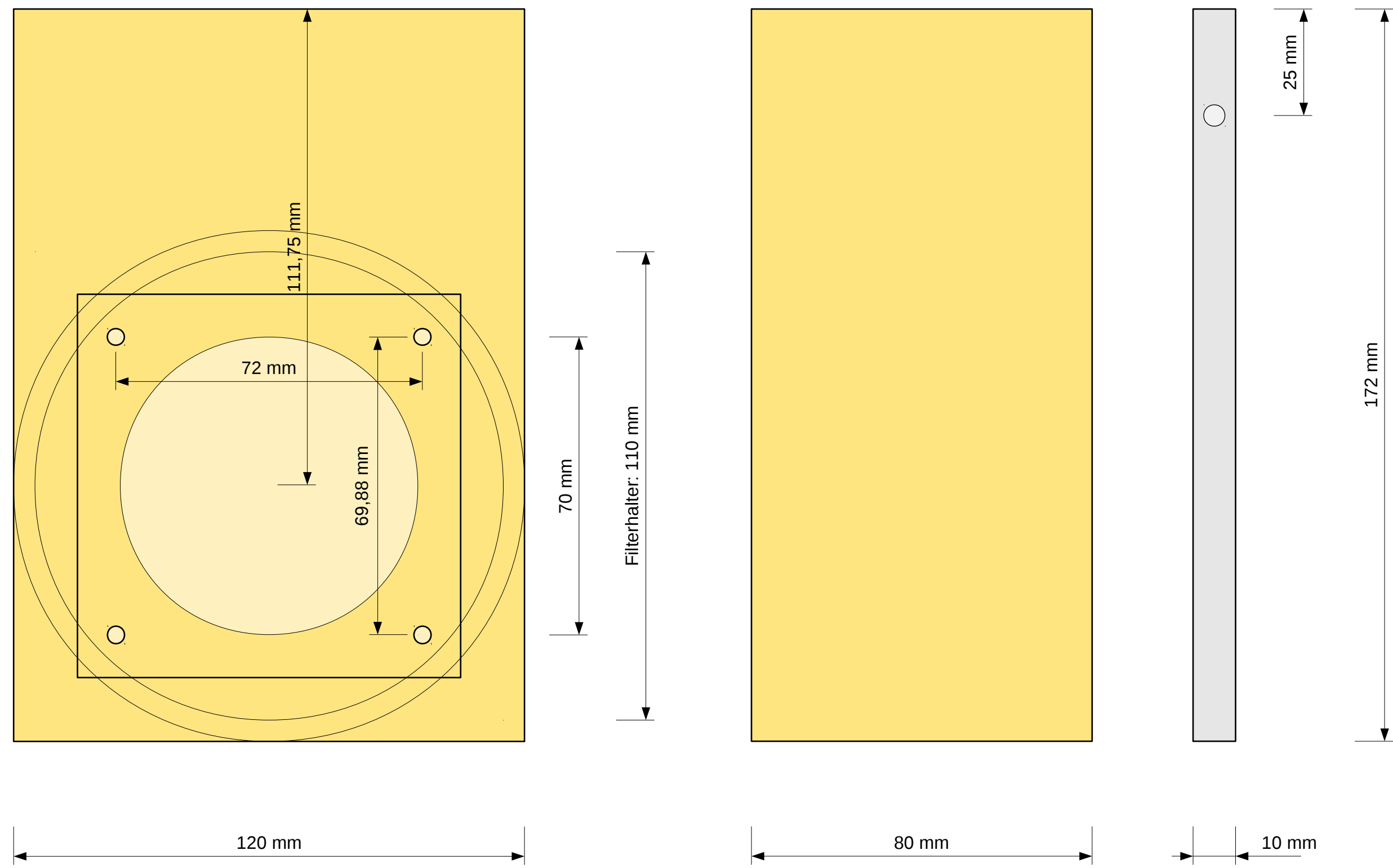

Konstruktion Dobson GSO 12 Zoll F4

Hut Seitenansicht, vereinfacht, Birke Multiplex 8..10 mm

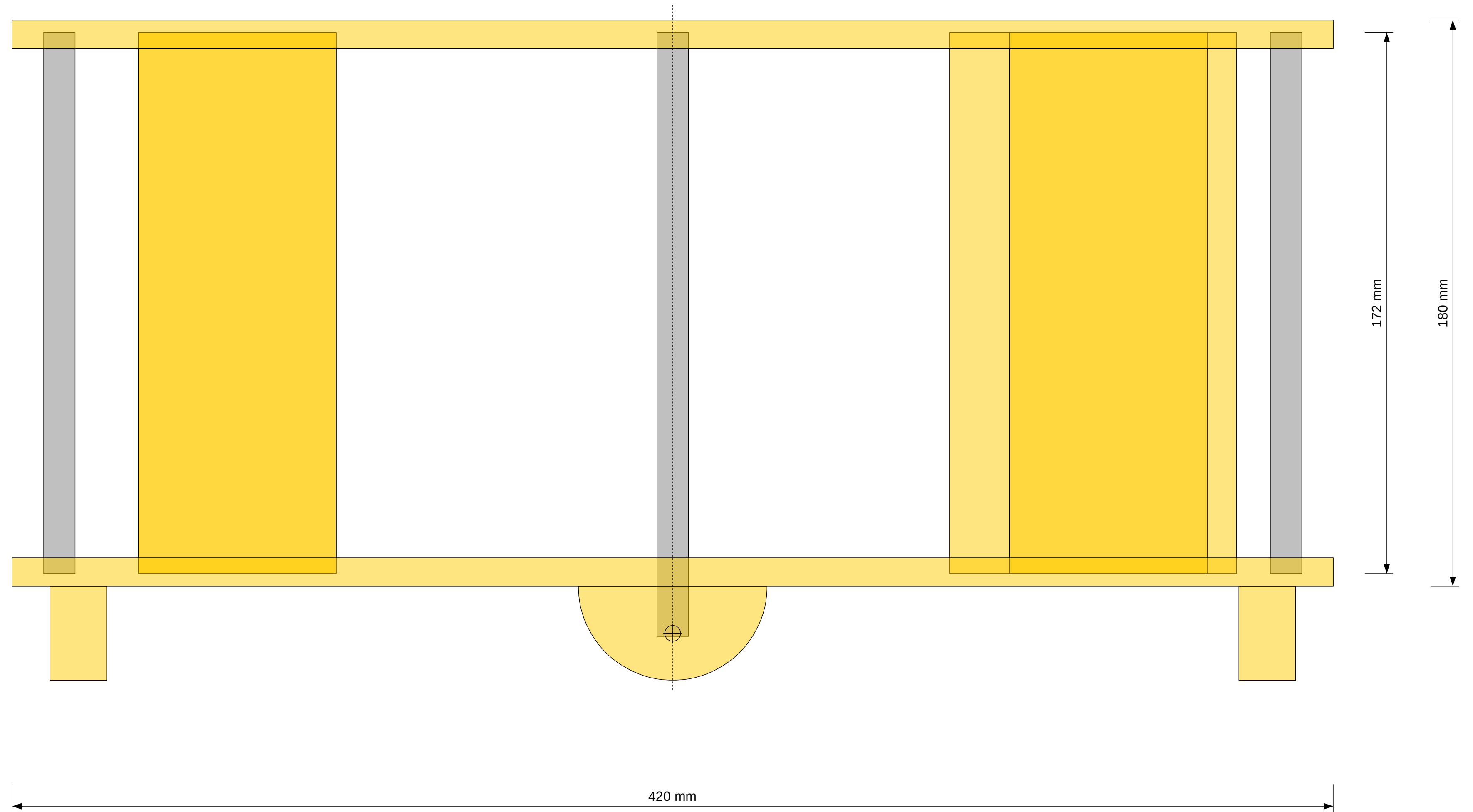

Konstruktion Dobson GSO 12 Zoll F4

Hut Seitenansicht 2, vereinfacht, Birke Multiplex 8..10 mm

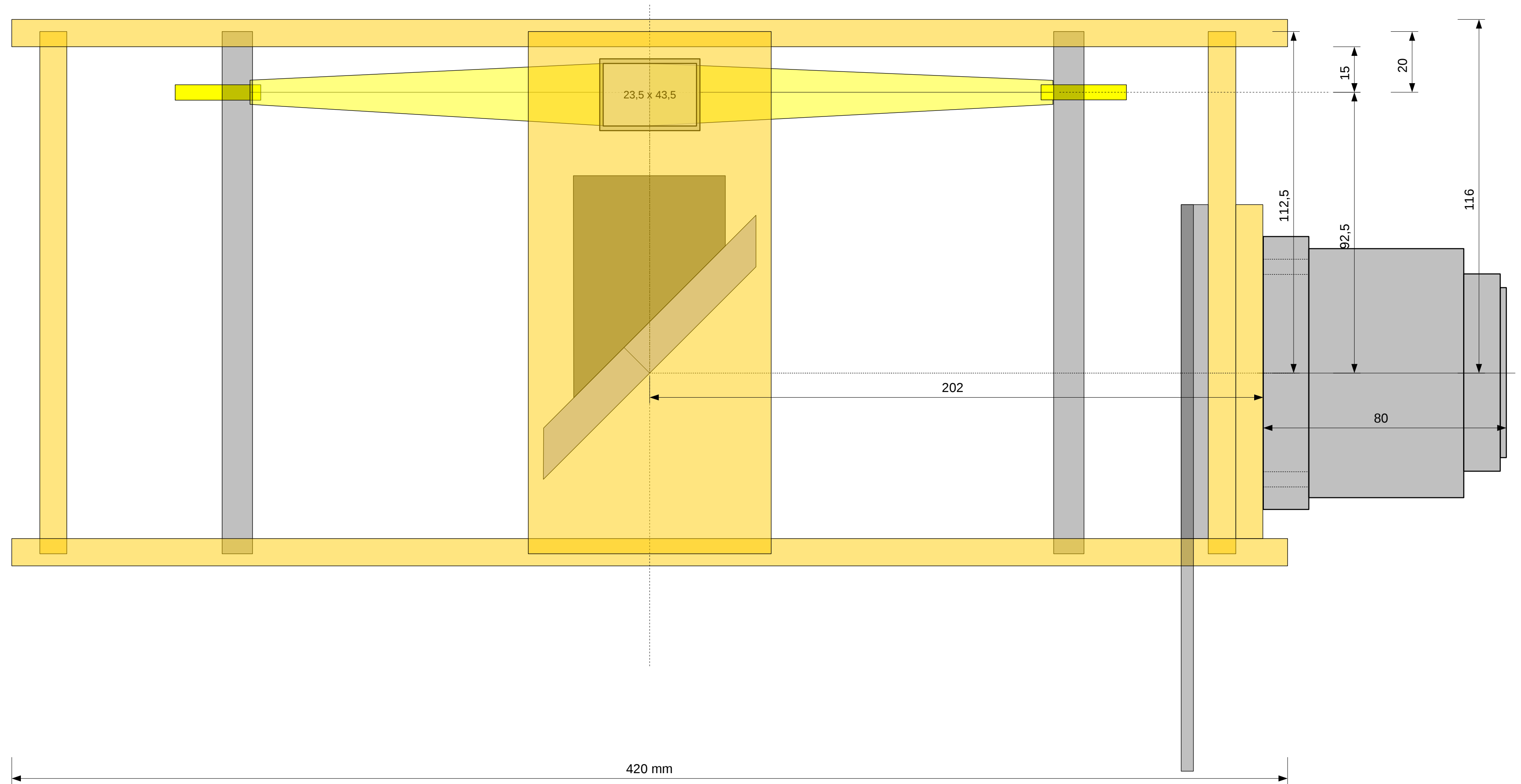

Konstruktion Dobson GSO 12 Zoll F4

Spiegelzelle Draufsicht, Alu-Profil-Rahmen 20x20

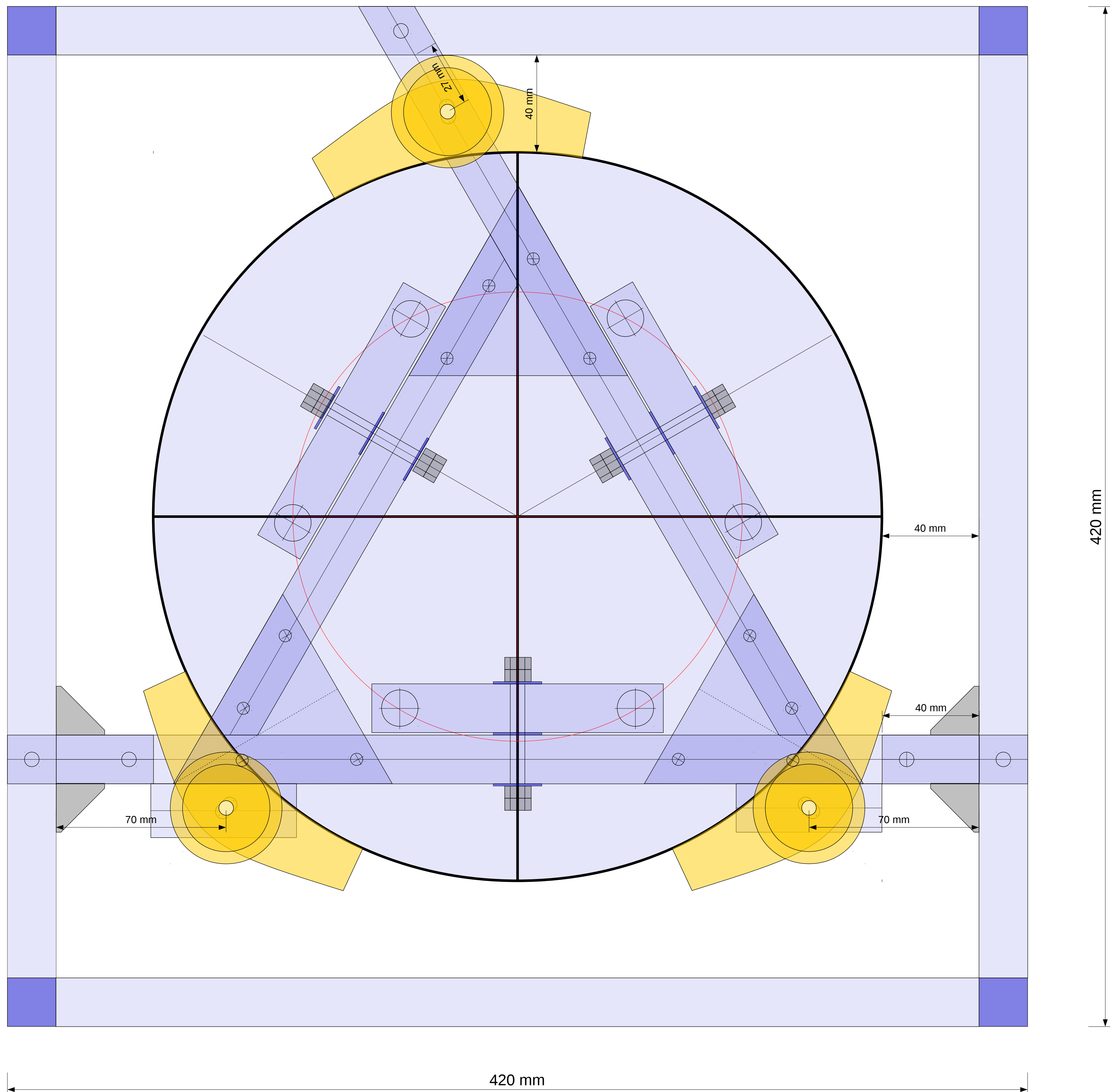

Konstruktion Dobson GSO 12 Zoll F4

Spiegelzelle, Seitenansicht vereinfacht, Alu-Profil-Rahmen 20x20

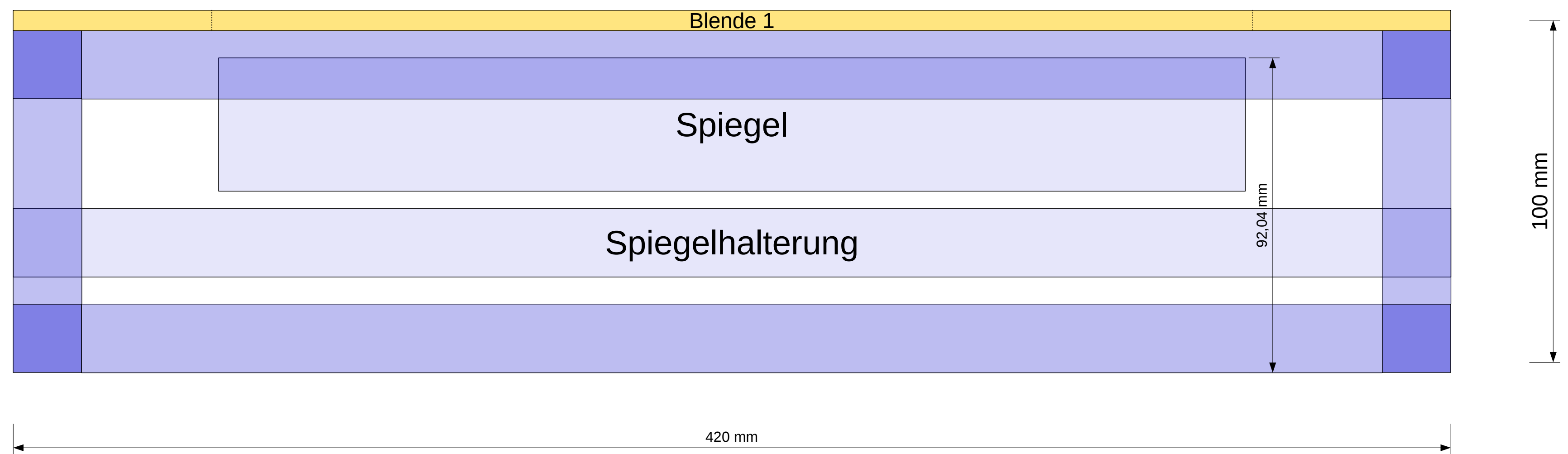

Konstruktion Dobson GSO 12 Zoll F4

Spiegelbox mit Hutring, Draufsicht vereinfacht, Alu-Profil-Rahmen 20x20, Birke Multiplex 6.8 mm

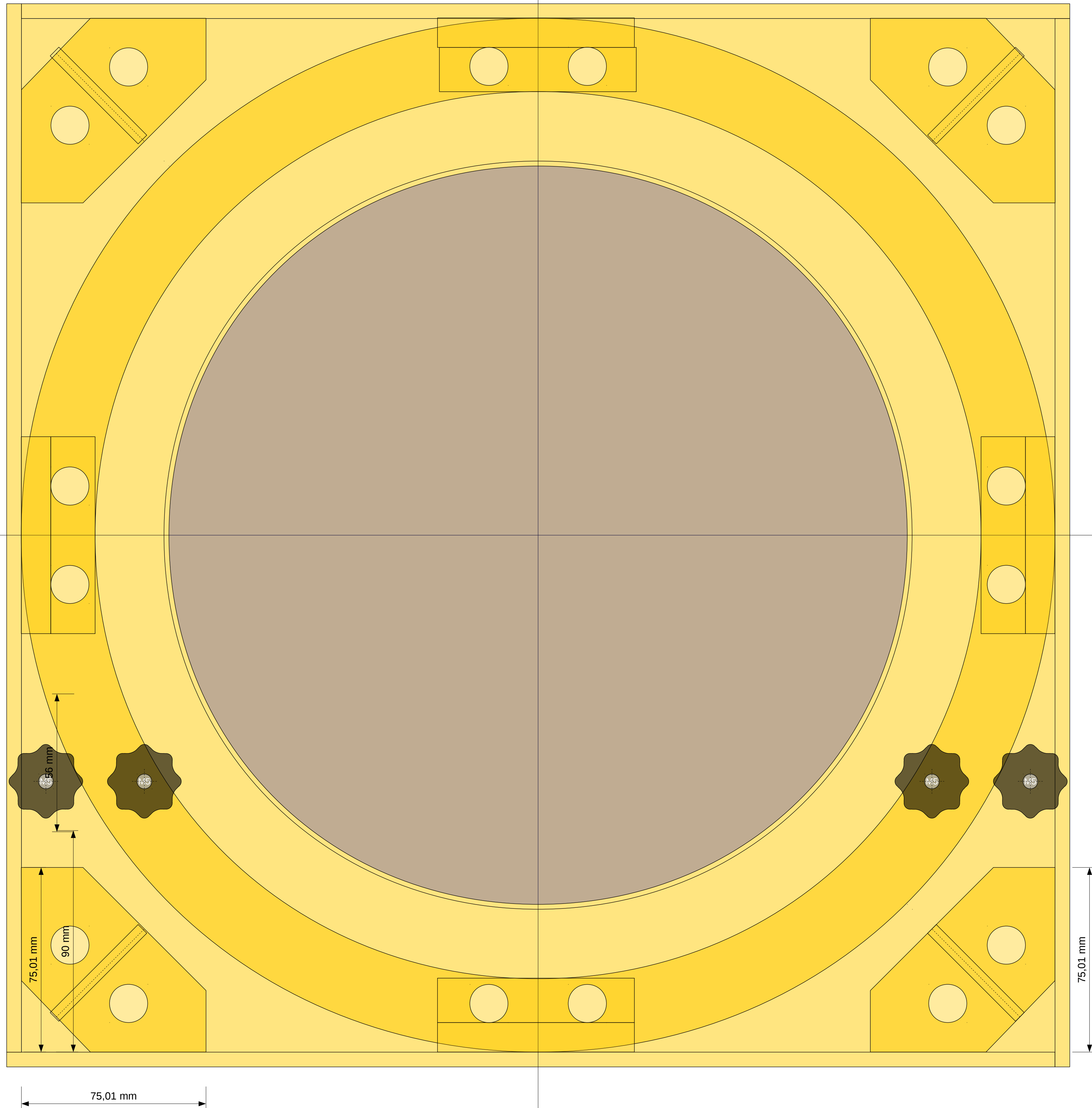

Konstruktion Dobson GSO 12 Zoll F4

Spiegelbox, Seitenansicht vereinfacht, Alu-Profil 20x20

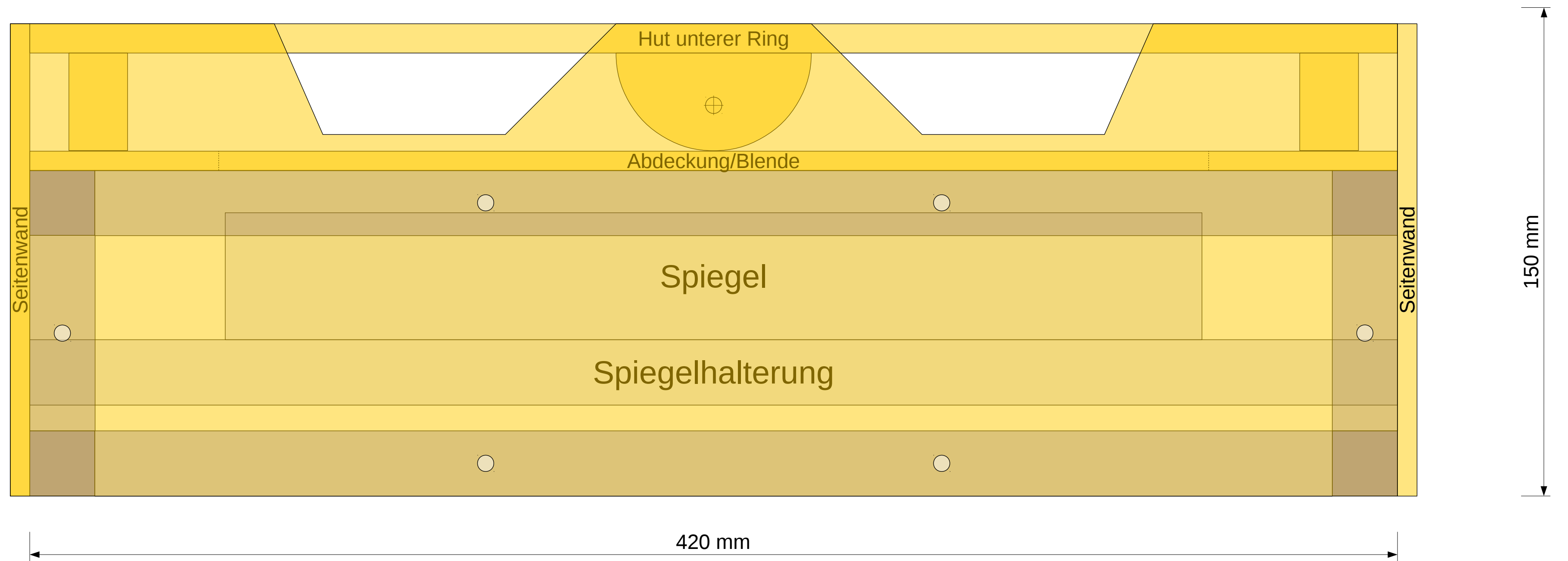

Konstruktion Dobson GSO 12 Zoll F4

Spiegelbox Abdeckung mit Blende, Draufsicht, Birke Multiplex 6 mm

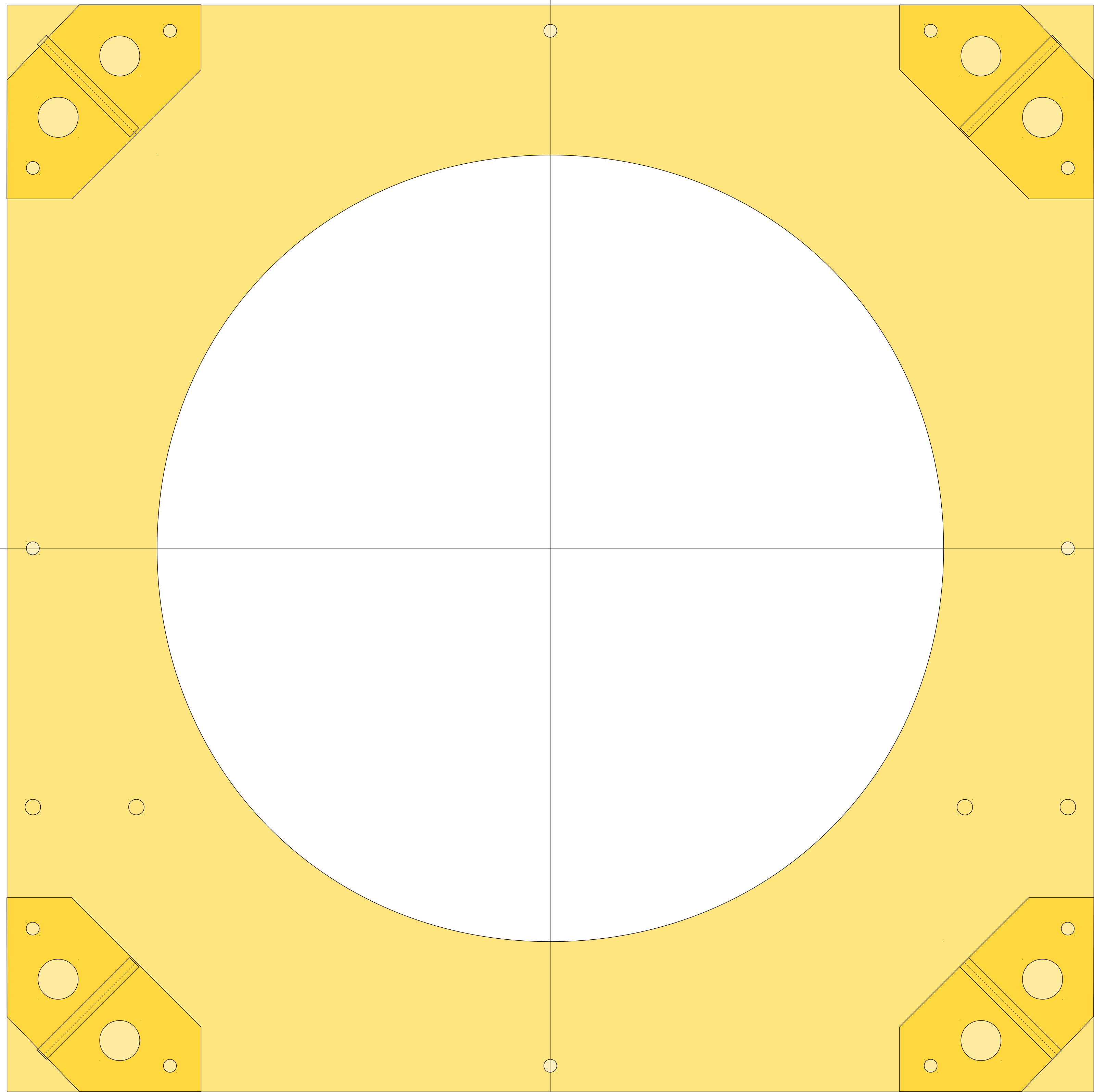

36 Nutensteine und 4x 90° Winkel

Konstruktion Dobson GSO 12 Zoll F4

Spiegelbox Seitenwände, Seitenansicht, Birke Multiplex 6 mm

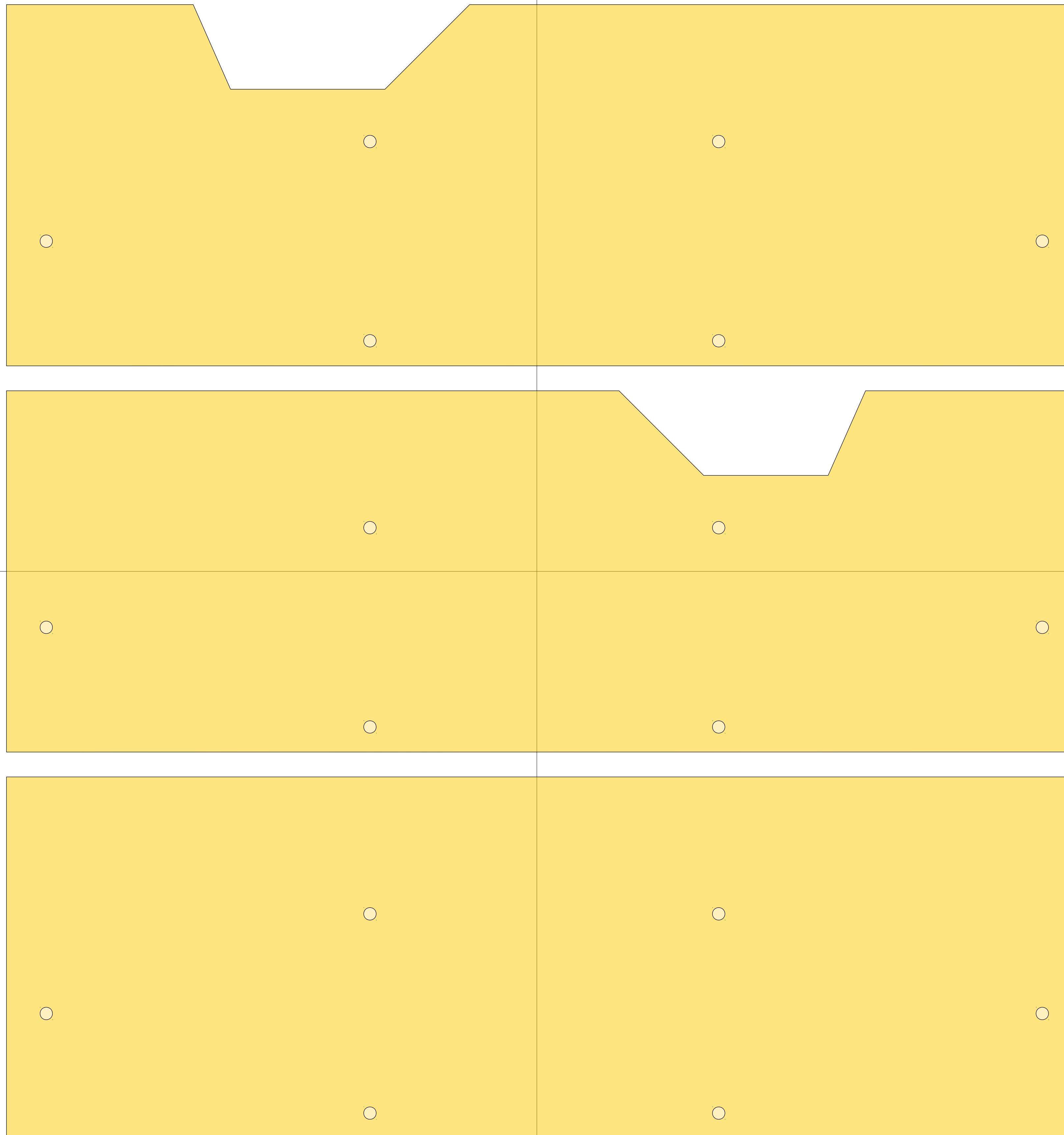

Konstruktion Dobson GSO 12 Zoll F4

Sichelrad, Seitenansicht, Birke Multiplex 12 mm + 4 mm und Buche 4 mm



Konstruktion Dobson GSO 12 Zoll F4

Rockerbox Seitenwände 1, Seitenansicht, Birke Multiplex 12 mm

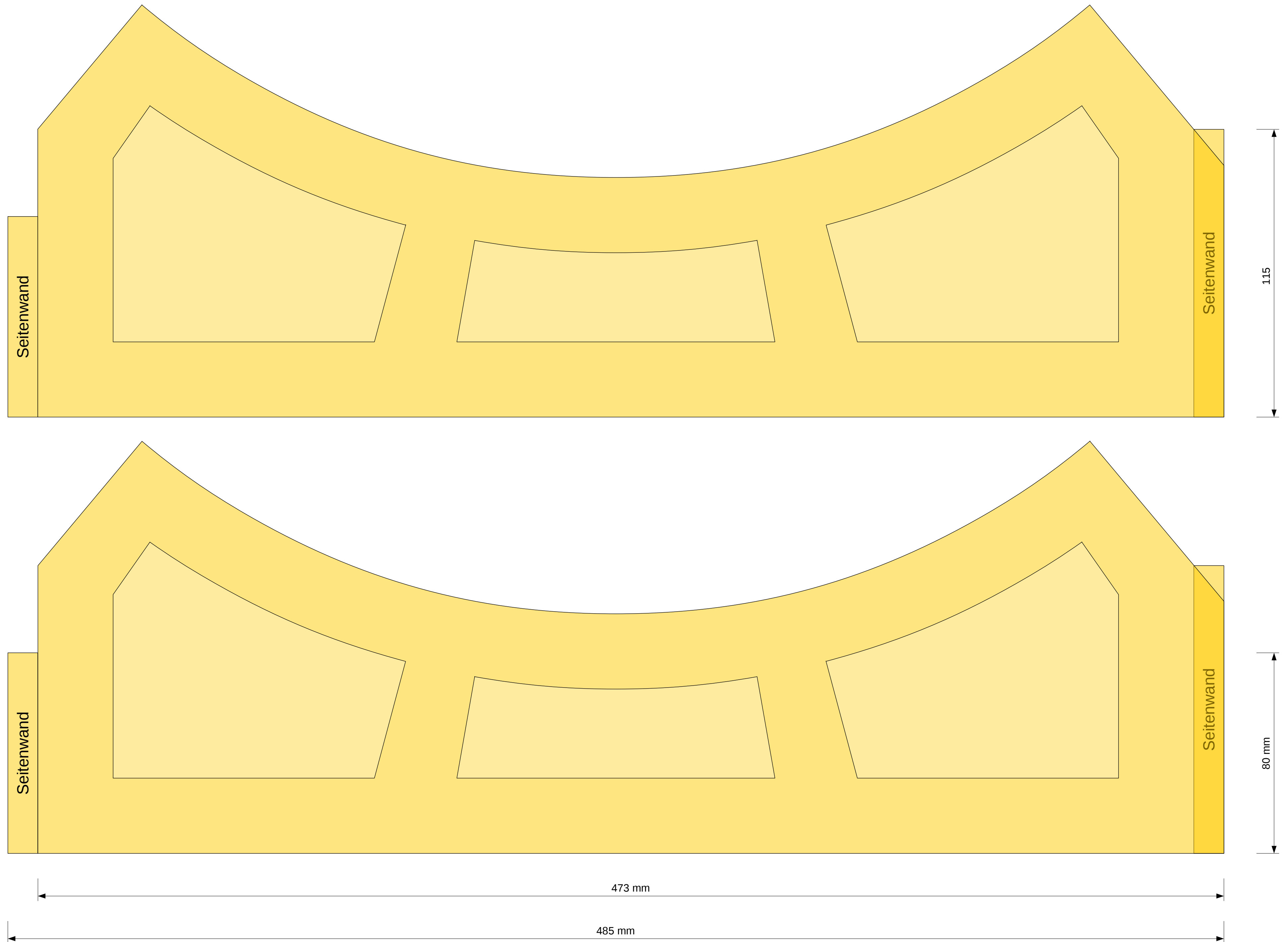

Konstruktion Dobson GSO 12 Zoll F4

Rockerbox Seitenwände 2, Seitenansicht, Birke Multiplex 12 mm

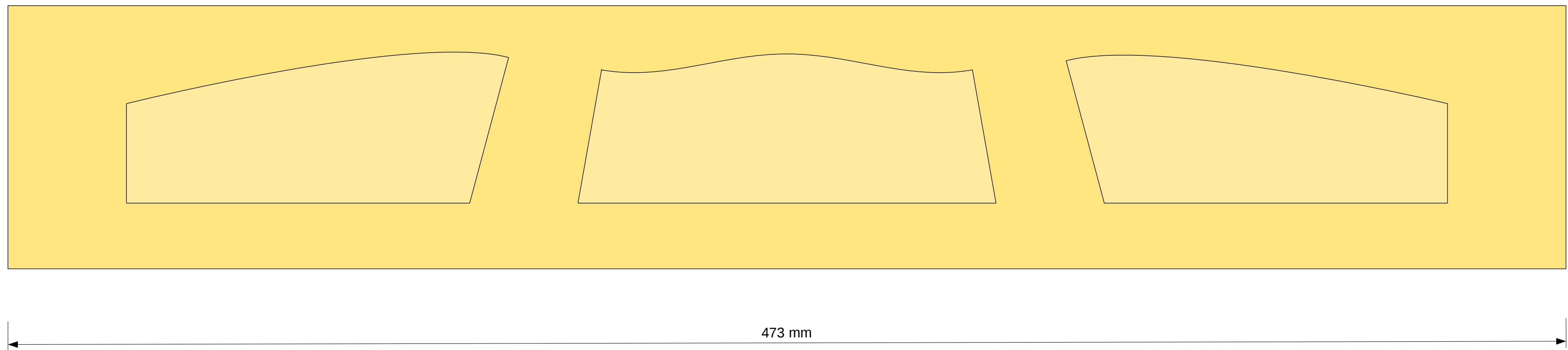
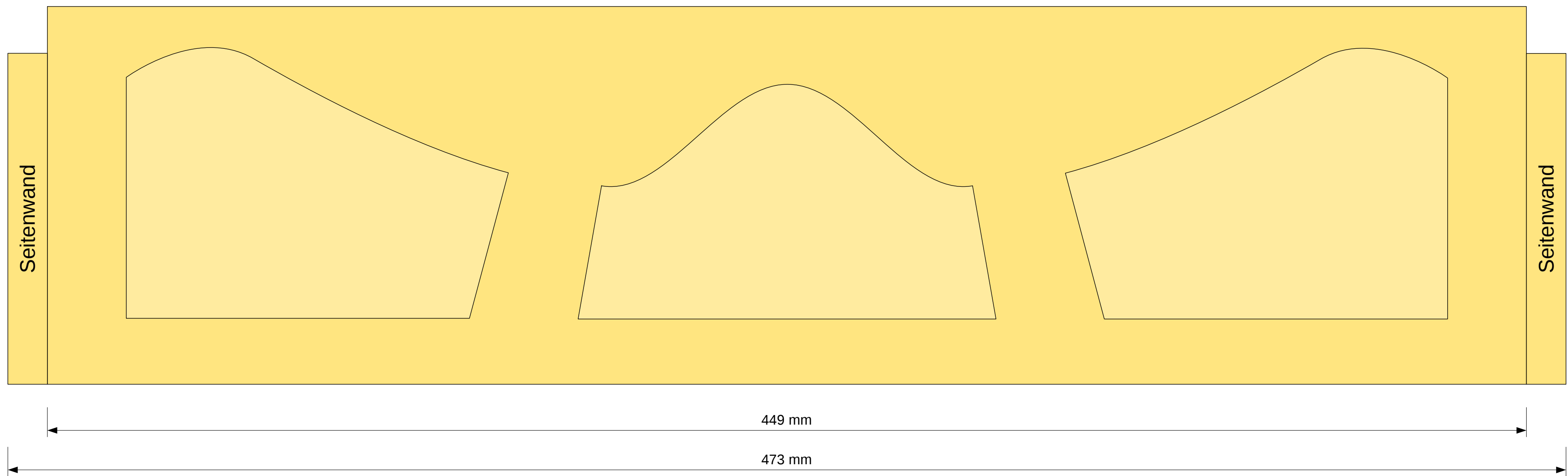

Konstruktion Dobson GSO 12 Zoll F4

Rockerbox Bodenplatte, Draufsicht, Birke Multiplex 12 mm

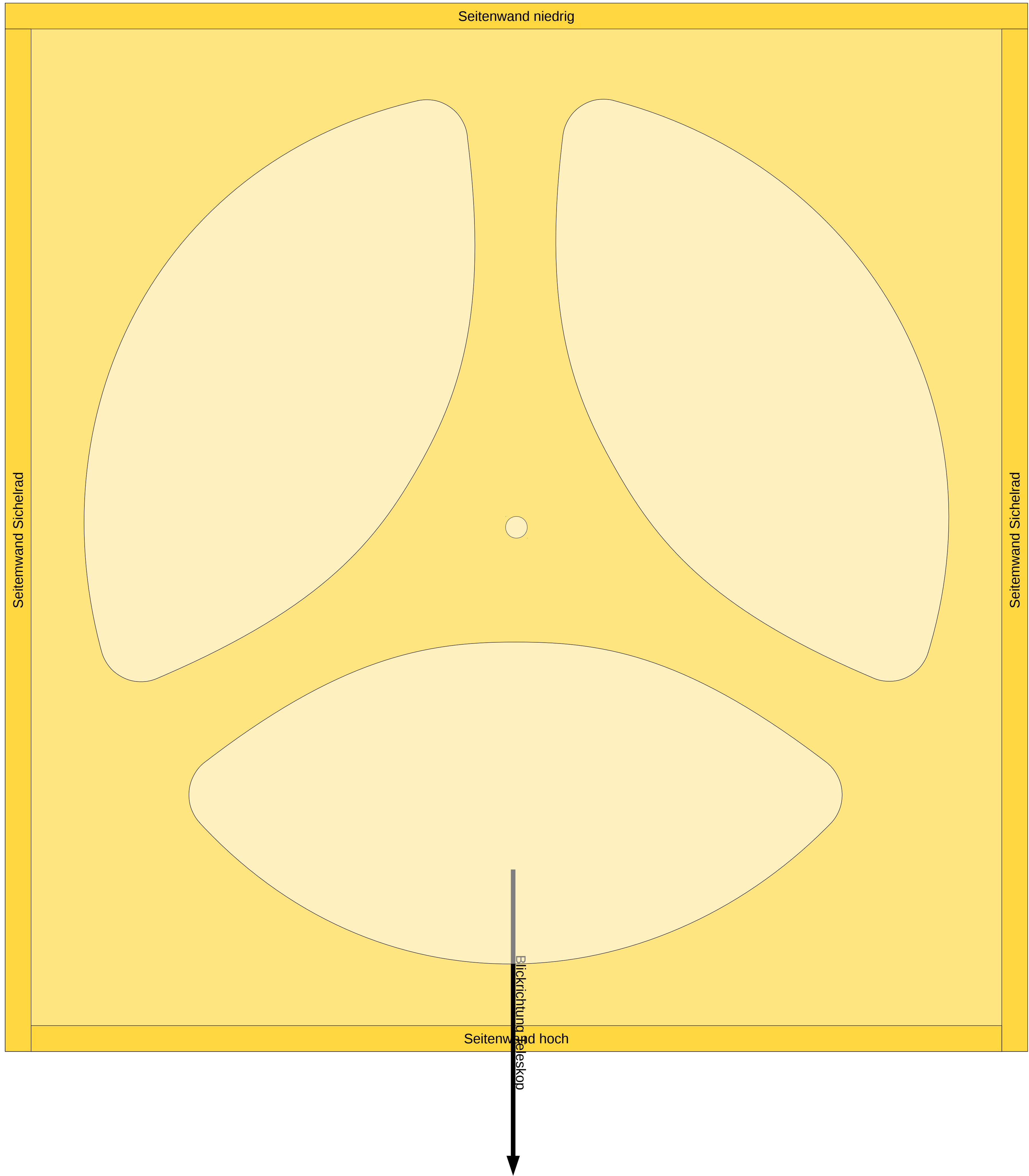

Konstruktion Dobson GSO 12 Zoll F4

Rockerbox Fuß, Draufsicht, Birke Multiplex 12 mm

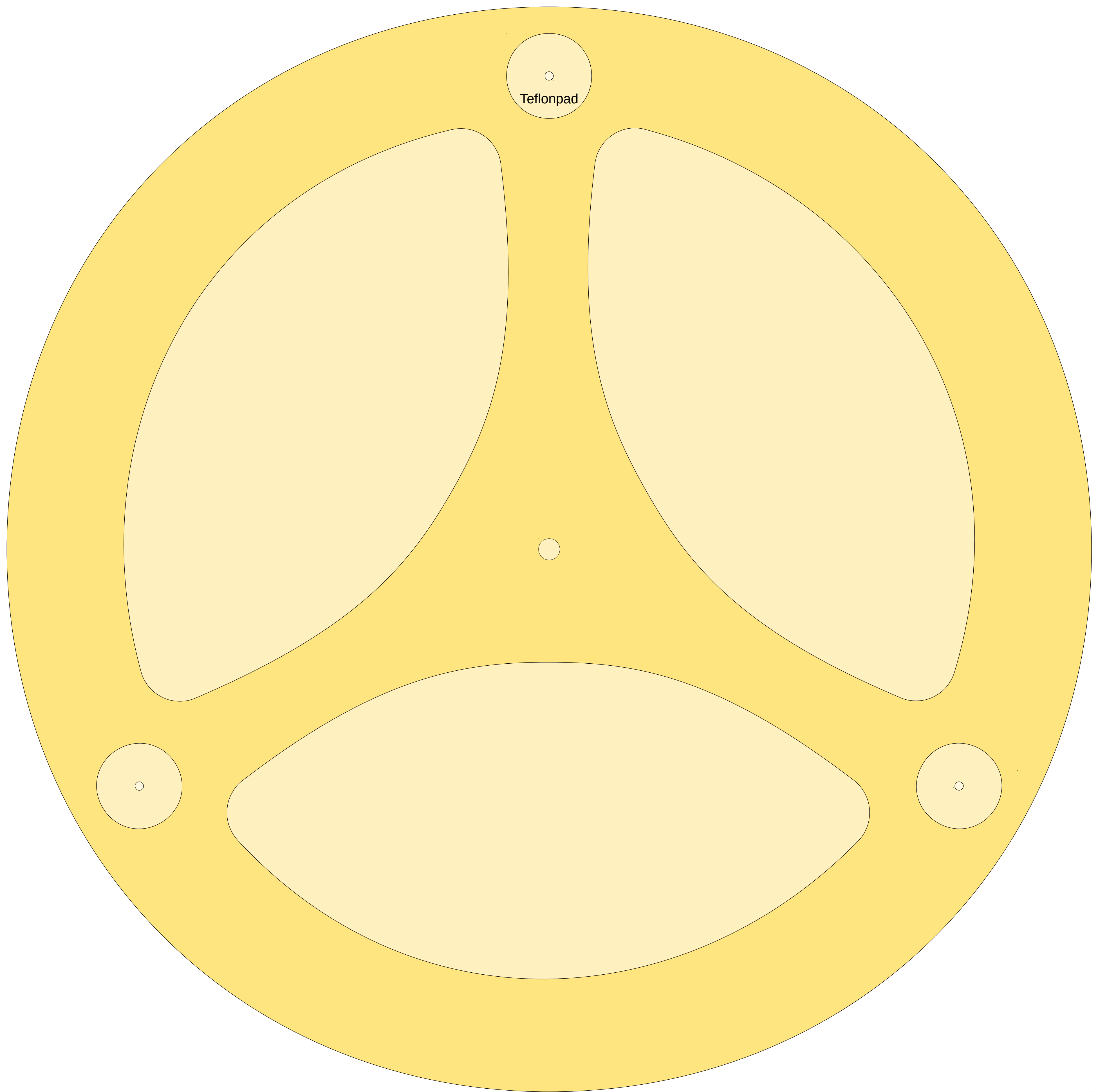

Konstruktion Dobson GSO 12 Zoll F4

Kleinteile 1

Klemmung am Hut für Stangen
Birke Multiplex 12 mm

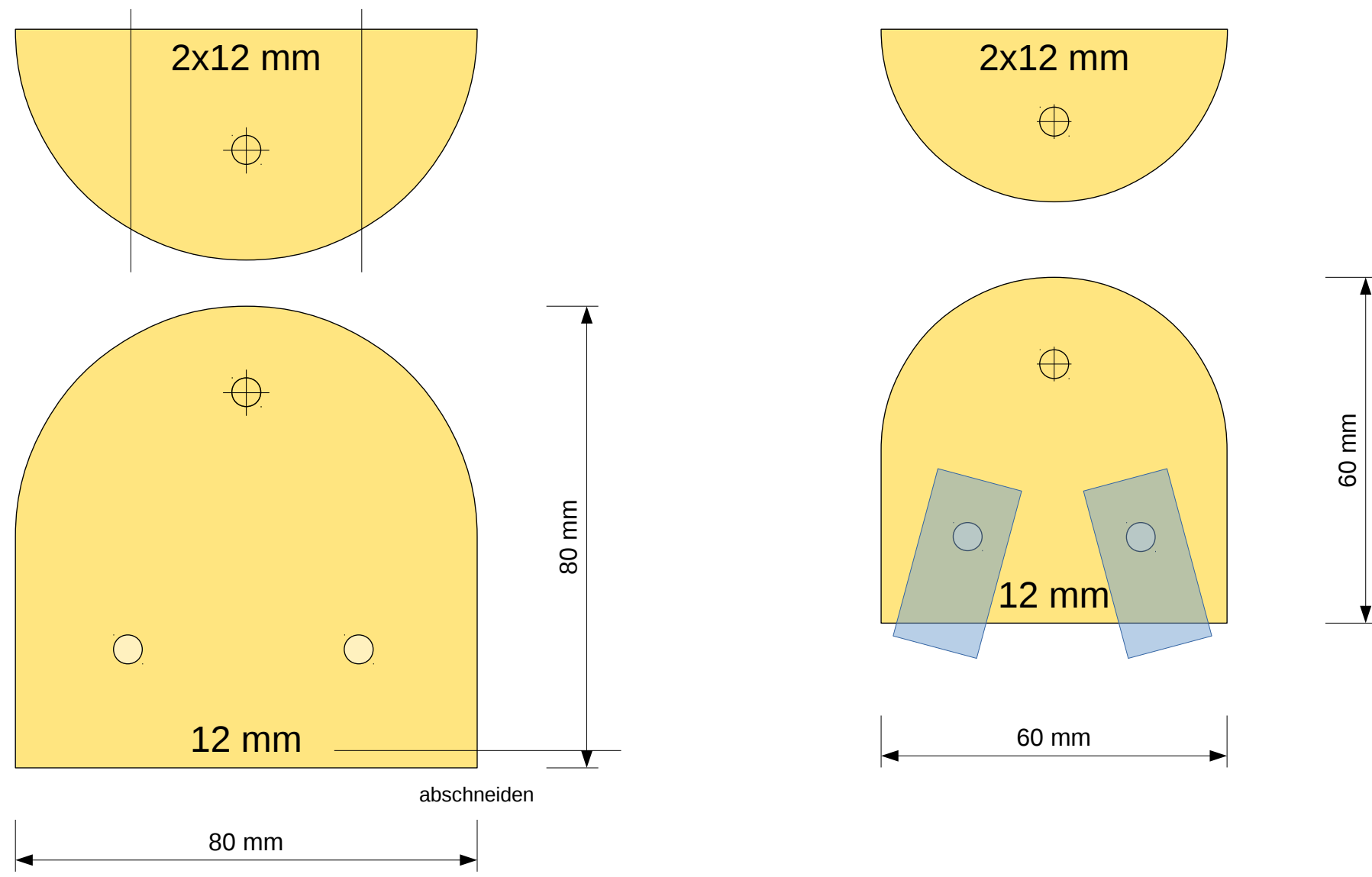

Block für Stangen
Birke Multiplex, 12 mm, 2x

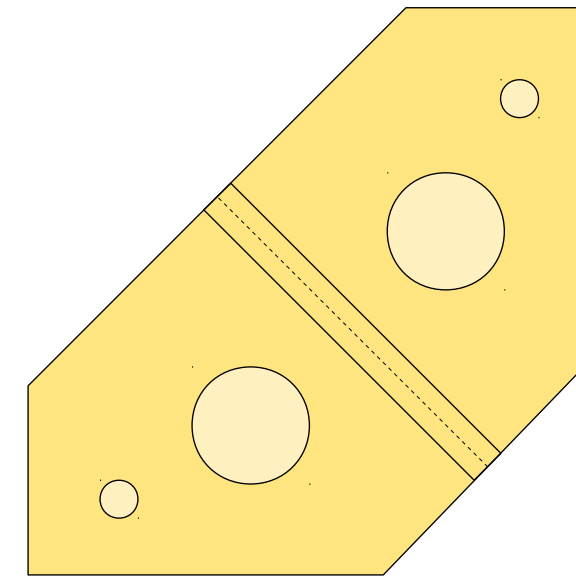

Halterung für Sucher
Birke Multiplex, 12 mm, 4x

Entwurf 1 Entwurf 2

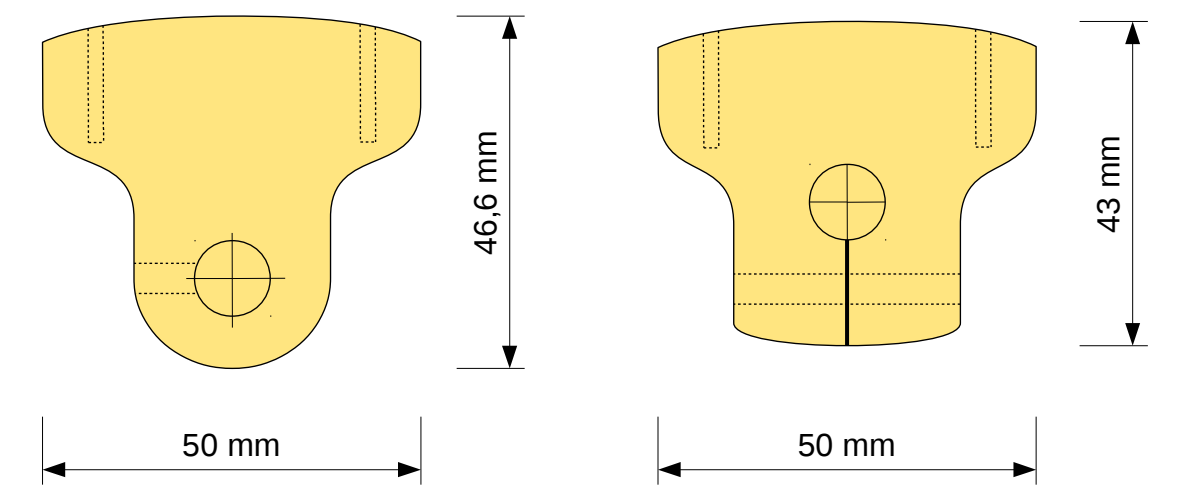

Spiegel Lateralhalterung
Birke Multiplex 2x12 mm

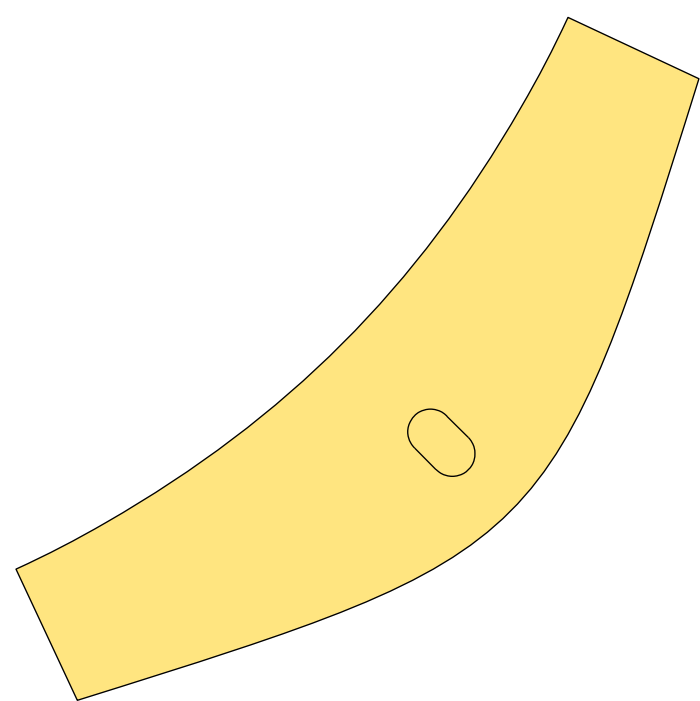

Birke Multiplex 2x9 mm

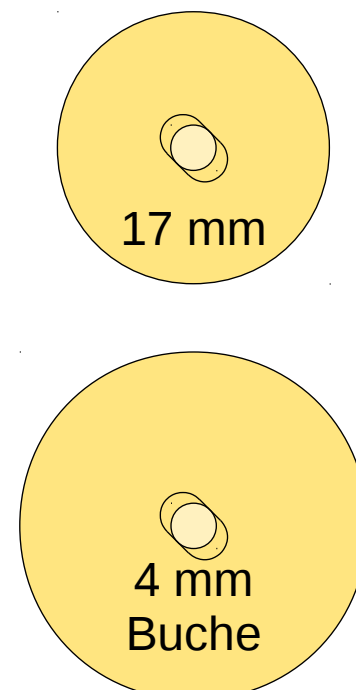

Stützdreieck für die Streben der Spiegelzelle
Aluminium 1,5 mm, 3x

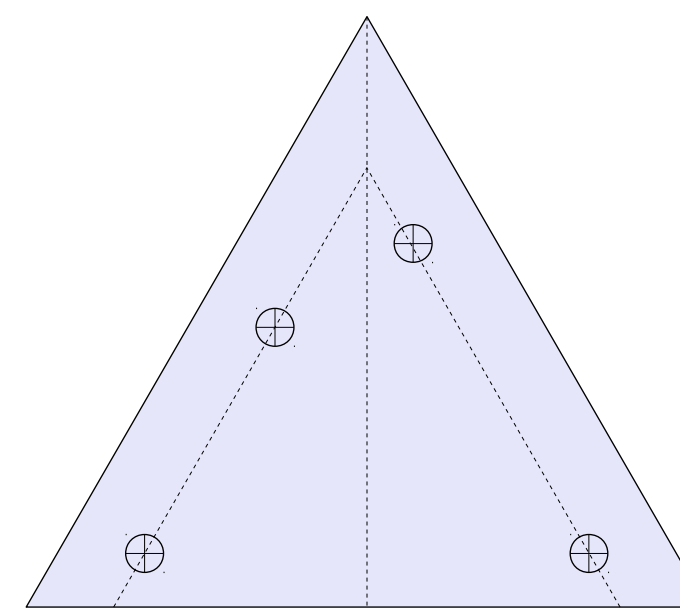

Halterung Fangspiegel
Aluminium-Rechteckrohr 1,5 mm Wandstärke

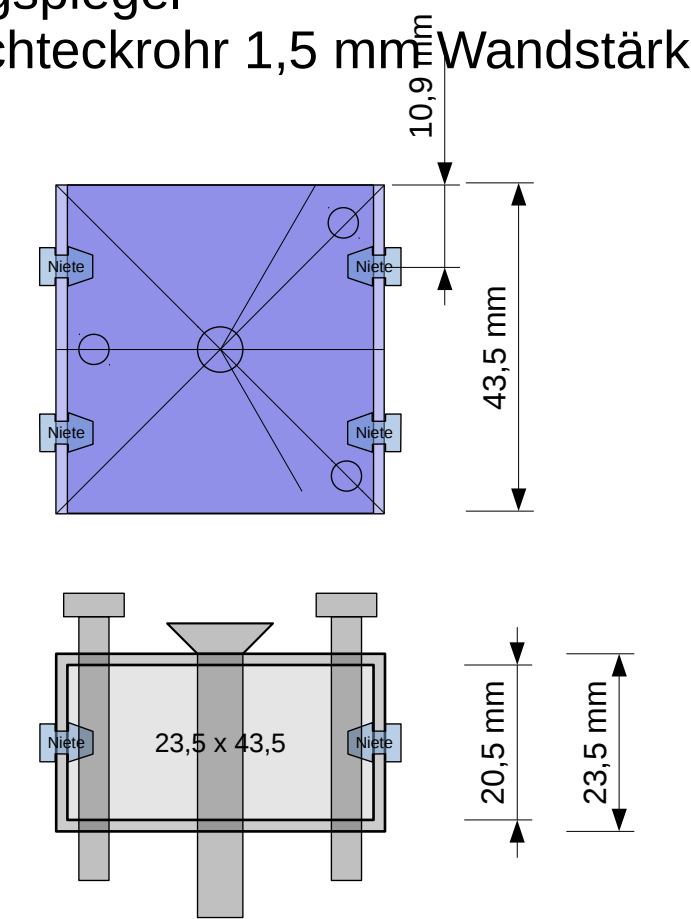

Rändelschrauben/Muttern zum Selbstbau
Birke Multiplex

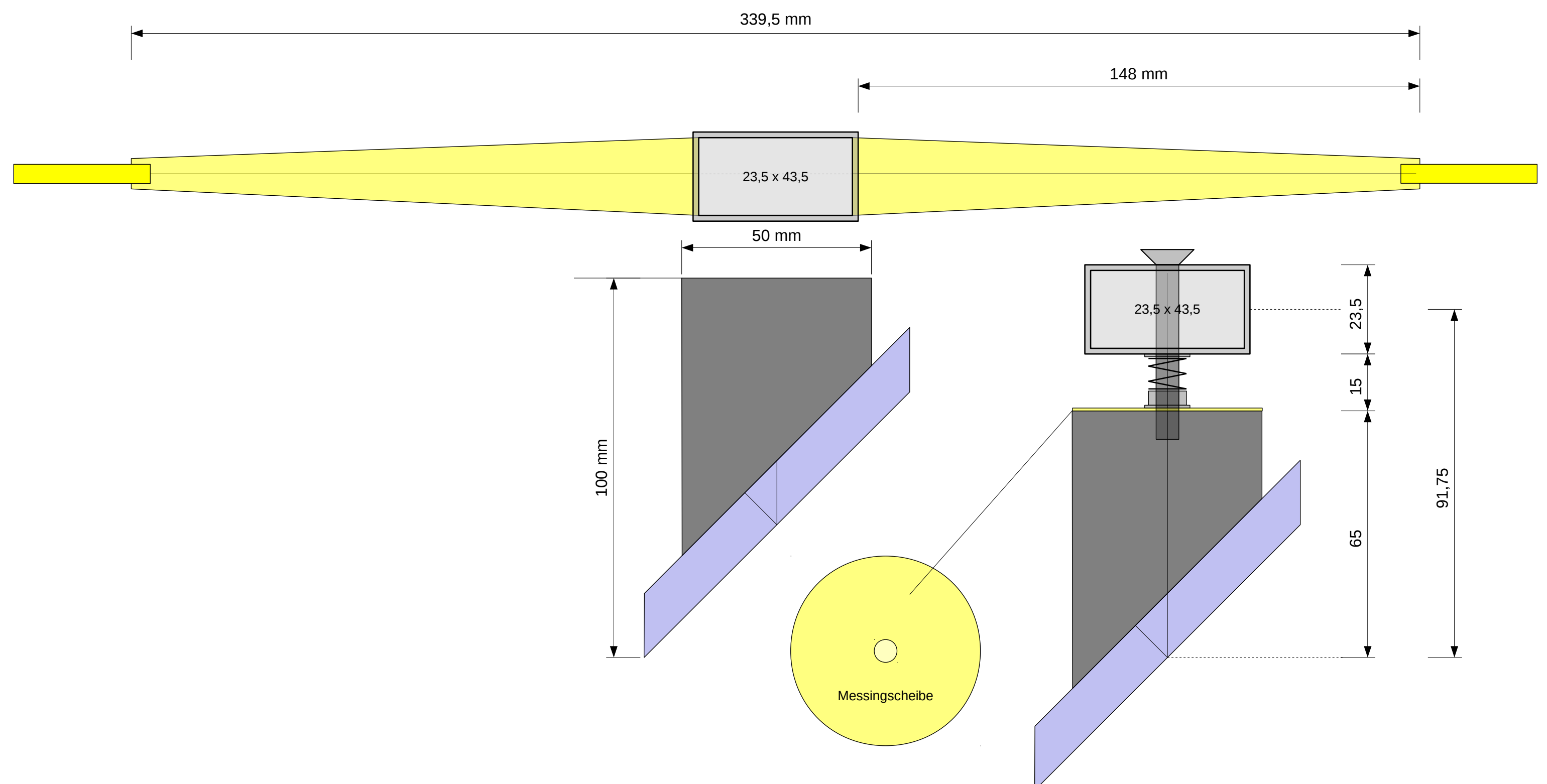
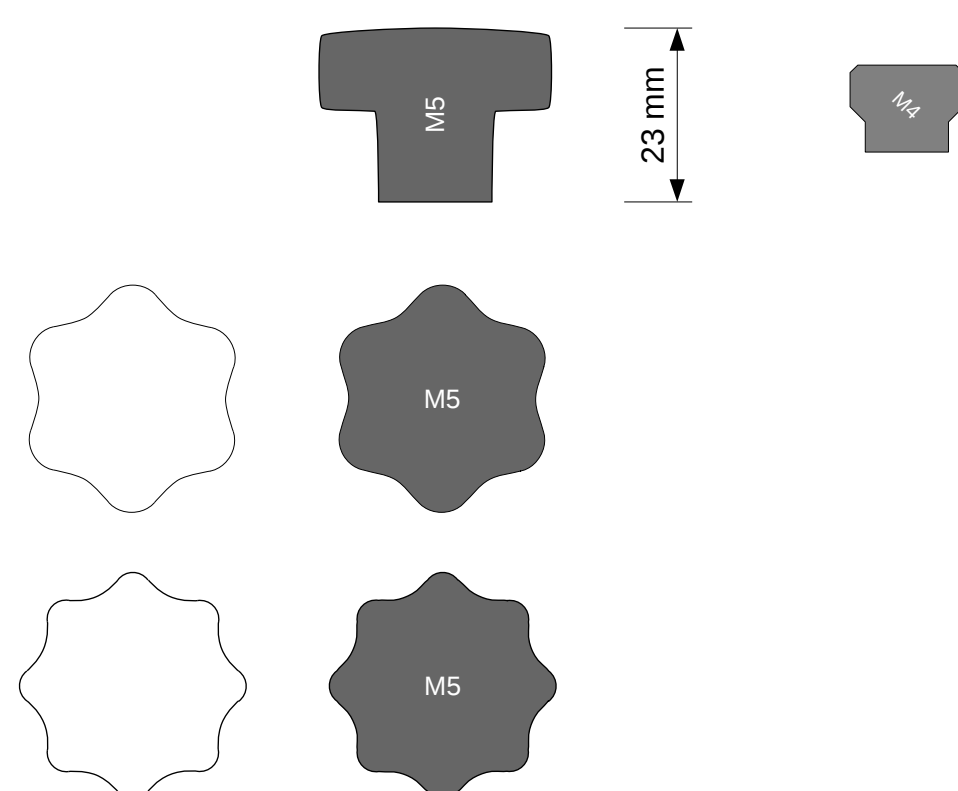

Konstruktion Dobson GSO 12 Zoll F4

Kleinteile 2

Bohrhilfe für Hutstangen
Birke oder Buche Multiplex 20..30 mm

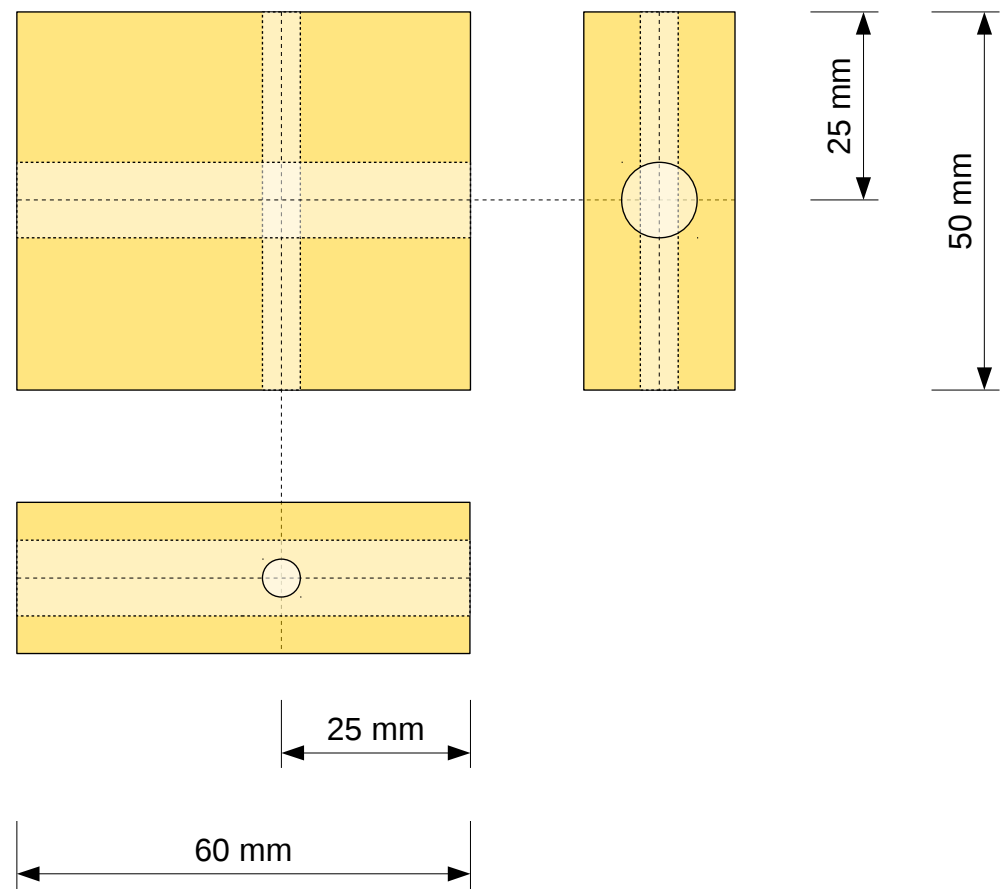

Bohrhilfe für Stangen
Birke oder Buche Multiplex 20..30 mm

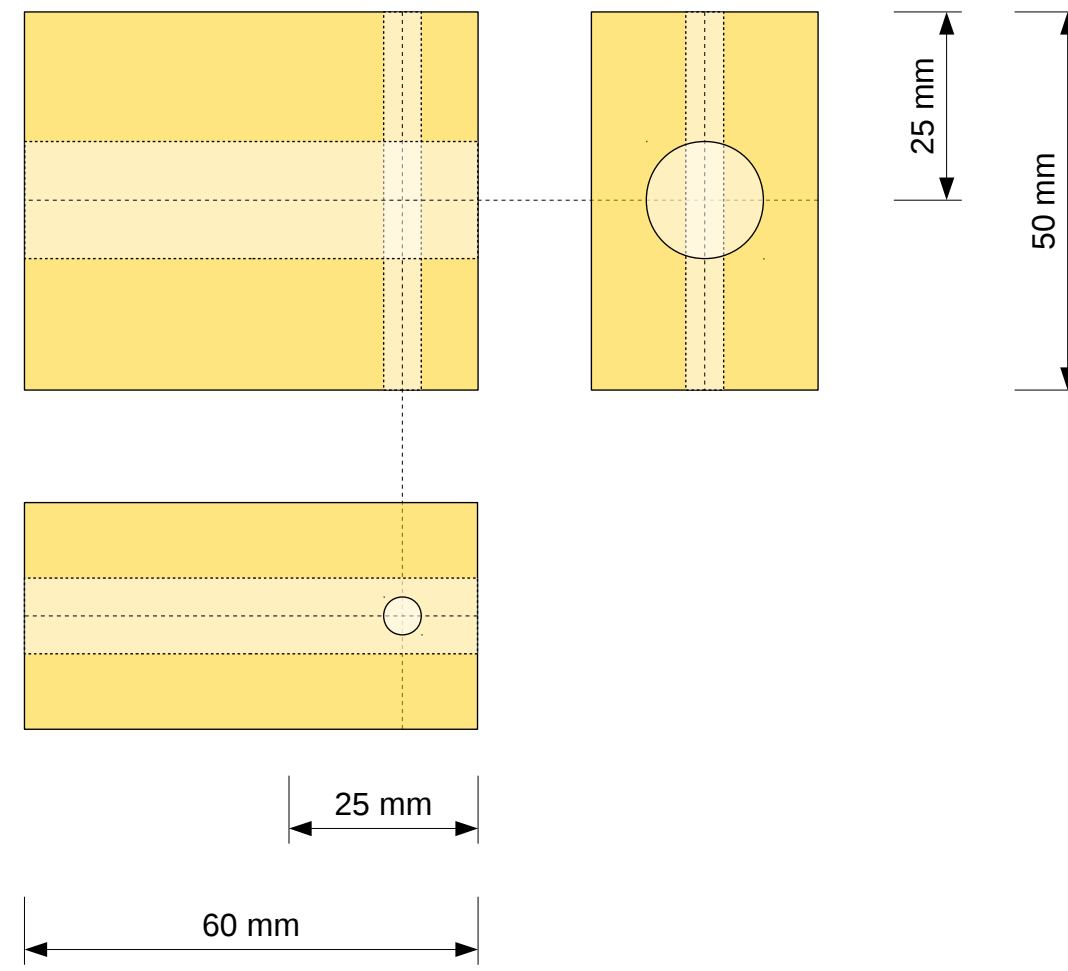

Blende vor dem Filterhalter
Flugzeugsperrholz 2 mm

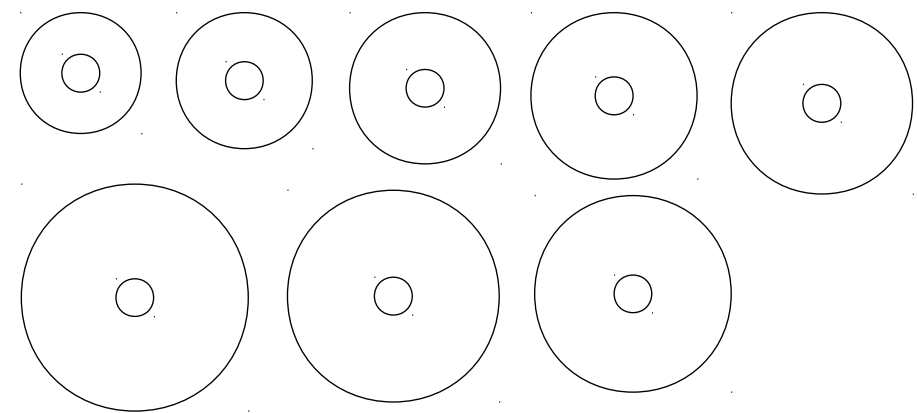
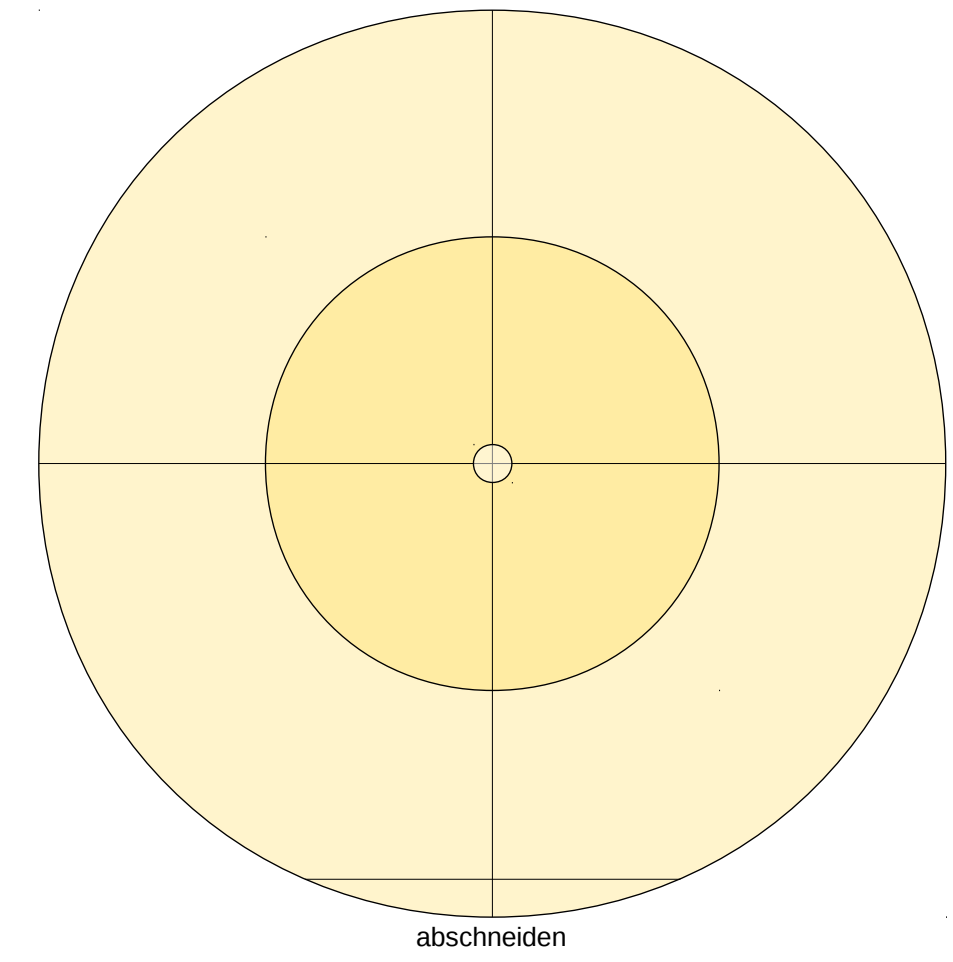

Abdeckung Spiegelbox
Sperrholz Pappel 2x 4 mm

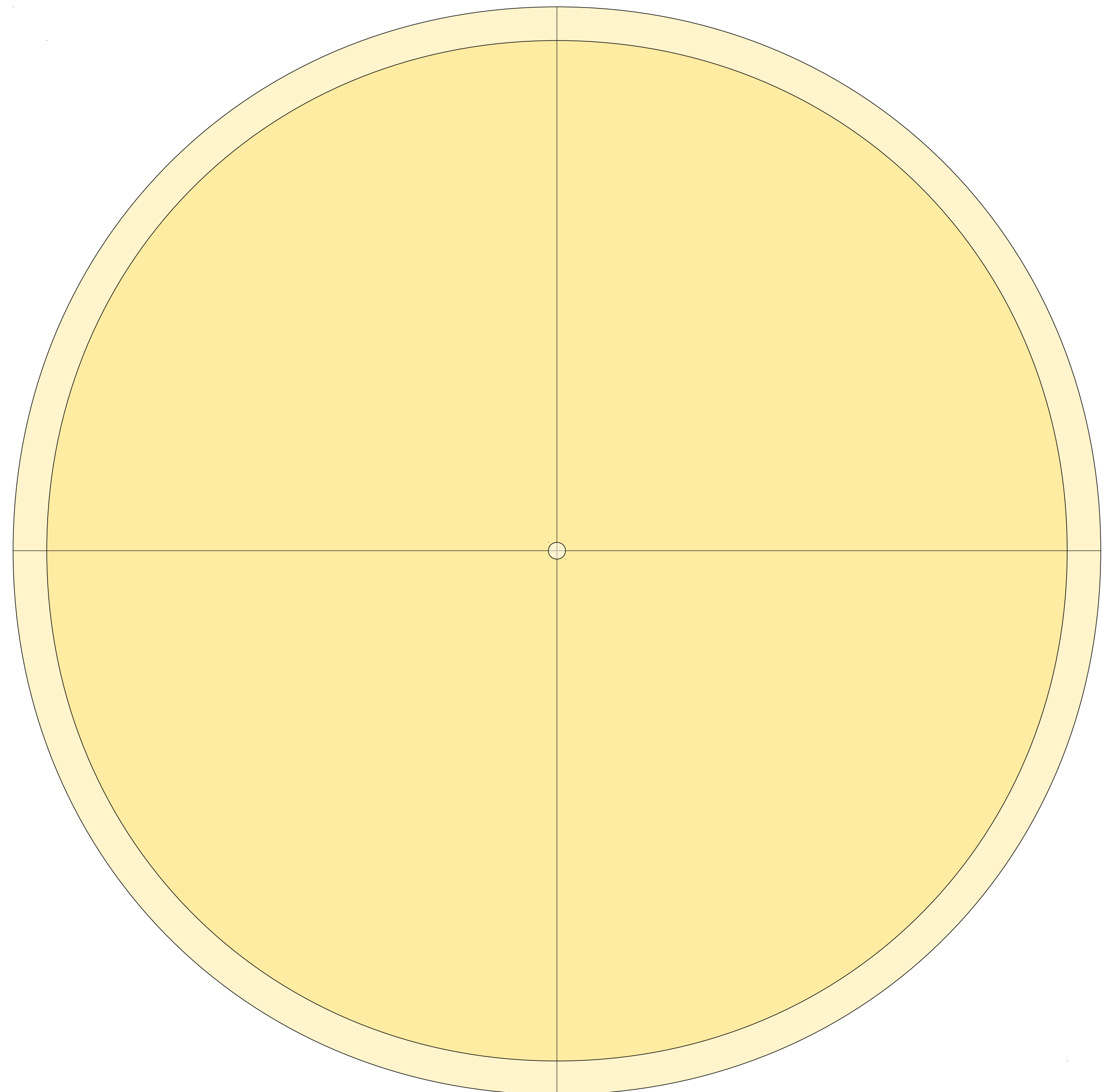

Bohr- und Fräshilfe für untere Blöcke

